

MODULE PLUS INDOOR



UM PRODUTO CLÁSSICO QUE CONTINUA A FAZER UM TRABALHO PERFEITO!

O Module Plus indoor é composto por uma série de perfis planos de alumínio em diferentes larguras que tem um módulo de 15,5 mm e 31 mm como perfis básicos. Os perfis podem ser “encaixados” de maneira fácil em tampas de plástico ou cliques para criar sinais de porta, pictogramas, diretórios, etc. São possíveis sinais de um lado para montagem na parede e sistemas de dois lados para pendurar ou bandeira.

a plataforma interna Module Plus não oferece apenas ao fabricante de sinalização uma solução padrão simples, versátil e flexível, mas também oferece espaço para o criador criativo de sinalização colocar sua própria ênfase e desenvolver produtos personalizados.



Paks Város Rendelőintézet

FÖLDSZINT

SEBÉSZET		NŐGYÓGYÁSZAT		RÖNTGEN - U	
01	Endoszkópos vizsgáló	F.21	Nőgyógyászat I.	F.12	Röntgen I. - F
02	Gipszelő	F.22	Nőgyógyászat II.	F.15	Röntgen II. - F
03	Sebészeti Műtő	F.24	Terhes ambulancia	F.17	Administráció
10	Sterilizáló			F.18	Ultraszhang

EMELET

SZAKRENDELÉSEK			LABORATÓRIUM		
02	Ortopédia	I.05	Belgyógyászat	I.10	Vérvételi labor
02	Gyermek pulmonológia	I.05	Sportorvos		Kémiai labor
02	Urológia	I.06	Reumatológia Oszteoporózis		Hematológia
03	Kardiológia	I.07	Szemészet		Vizelet labor
04	Gasztroenterológia	I.08	Fül-orr-gégészeti		Hűtőszoba
IGAZGATÓSÁG					
6	Gazdasági iroda	I.14	Igazgatók	I.14	Vezetői asztal

EMELET

01	Könyvtár	Személyzeti helyiségek		Gépszeti h
----	----------	------------------------	--	------------



PERFIS DE TEXTO EM ALUMÍNIO

código produto perfil

ANO 1 300	300 mm mill finish / brut	5m/l
ANO 1 250	250 mm mill finish / brut	5m/l
ANO 1 187	187 mm mill finish / brut	5m/l
ANO 1 156	156 mm mill finish / brut	5m/l
ANO 1 125	125 mm mill finish / brut	5m/l
ANO 1 093	93 mm mill finish / brut	5m/l
ANO 1 062	62 mm mill finish / brut	5m/l
ANO 1 046	46 mm mill finish / brut	5m/l
ANO 1 031	31 mm mill finish / brut	5m/l
ANO 1 015	15 mm mill finish / brut	5m/l

1. bruto 2. anodizado 4. anodizado dourado

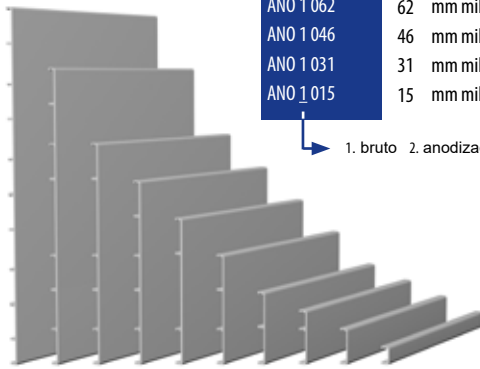

300 250 187 156 125 93 62 46 31 15 mm

PERFIL DE CORREDOR EM ALUMÍNIO

código produto perfil informação esp.

ASO 1 093	93 mm	89,5 mm	≤1,6 mm
ASO 1 062	62 mm	58 mm	≤1,6 mm
ASO 1 046	46,5 mm	42,5 mm	≤1,2 mm
ASO 1 031	31 mm	27 mm	≤1,0 mm
ASO 1 015	15,5 mm	11,5 mm	≤1,0 mm

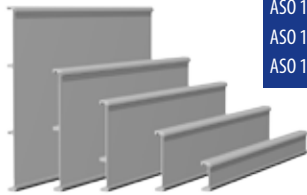

93 62 46 31 15 mm

ASO 1 031.2S	31 mm	2 x 13 mm	≤1,0 mm
--------------	-------	-----------	---------

ASO 1 031.SP	31 mm	custom	≤1,2 mm
--------------	-------	--------	---------

1. bruto 2. anodizado 4. anodizado dourado

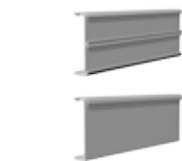

TOPOS DE UMA FACE

código produto dimensão

APE 3 250	250 mm black / noir
APE 3 218	218 mm black / noir
APE 3 187	187 mm black / noir
APE 3 156	156 mm black / noir
APE 3 125	125 mm black / noir
APE 3 093	93 mm black / noir
APE 3 062	62 mm black / noir
APE 3 046	46,5 mm black / noir
APE 3 031	31 mm black / noir
APE 3 015	15,5 mm black / noir

1. branco 2. cinza 3. preto

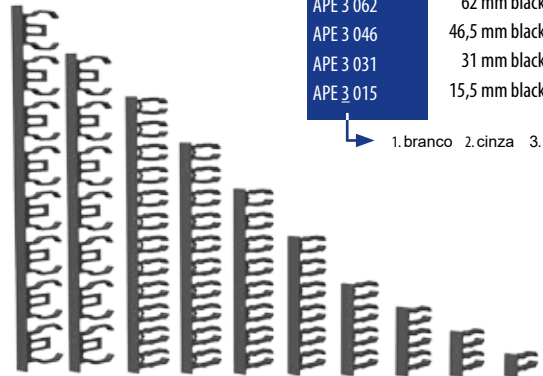

250 218 187 156 125 93 62 46 31 15mm

TOPOS PARA DUPLA FACE

código produto dimensão

APD 3 300	300 mm
APD 3 250	250 mm
APD 3 187	187 mm
APD 3 156	156 mm
APD 3 125	125 mm
APD 3 093	93 mm
APD 3 062	62 mm

3. preto

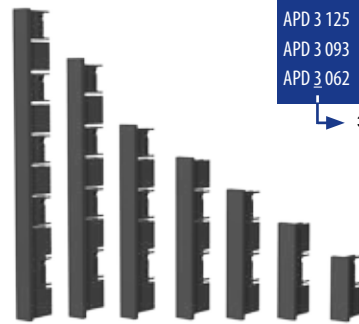

300 250 187 156 125 93 62 mm

MONTADO NA PAREDE

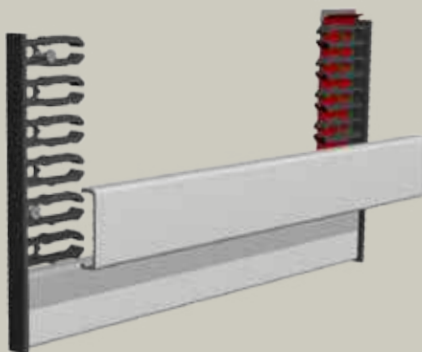

BANDEIROLA

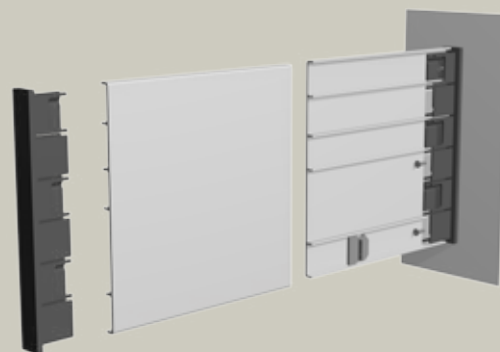

KIT DE SUSPENSÃO



código produto descrição
APC4101 2x fixadores cônico + cabo de 1,5m

existe mais fixadores no sistemas de suspensão.



código produto descrição
APC3_000 clip suspensão PVC
 ↳ 2. cinza 3. preto



APC4_500 perfil de suspensão de metal (5 mt.)
 clipe de suspensão de metal (30 mm)



código produto
APC6_000 cunha ABS preto

VENTOSA



VACUUMC2
VACUUMC

CHAVE



código produto
APK1000

SUPORTE DE MESA



código produto descrição
APC7000 cunha



APW3_031 Tampa triangular 31mm
 ↳ 1. branco 2. cinza 3. preto

APW3_062 Tampa triangular 61mm
 ↳ 2. cinza 3. preto

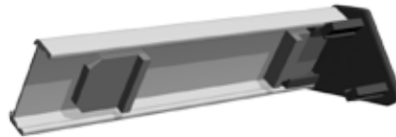

SISTEMA DE SUSPENSÃO

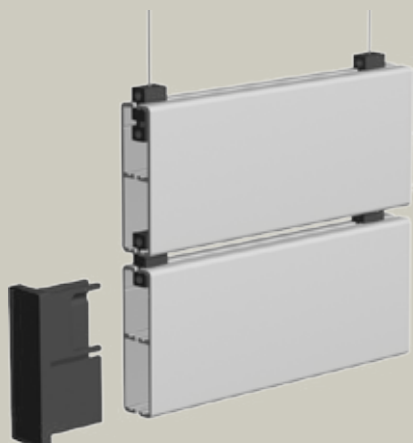

SUPORTE DE MESA

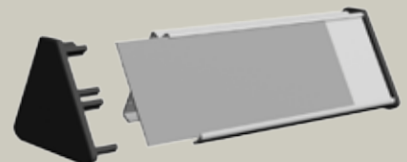
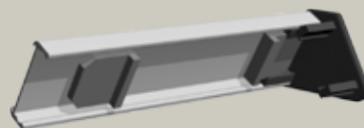

PERFIS LATERAIS EM ALUMÍNIO

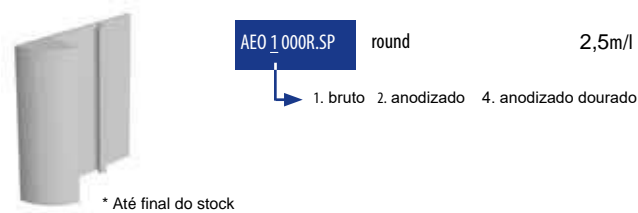
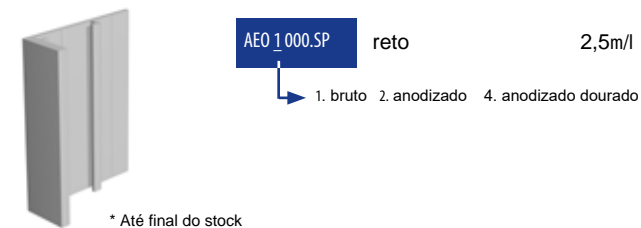
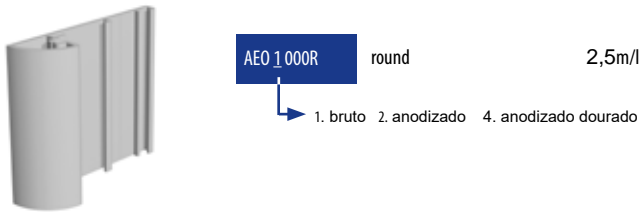
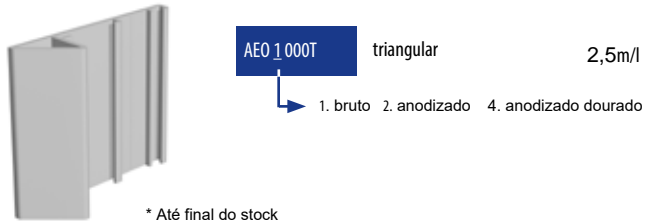
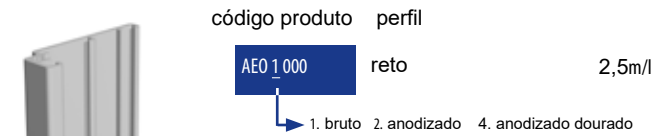

PERFIS DE SUPORTE / DIVISOR

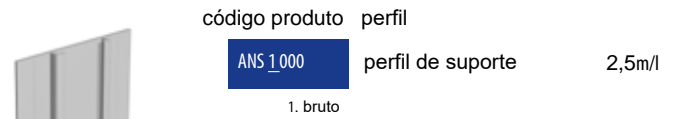

COMBINAÇÃO DE PERFIL LATERAIS

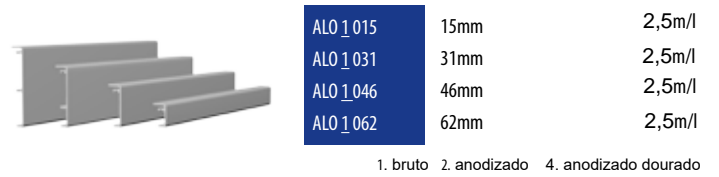
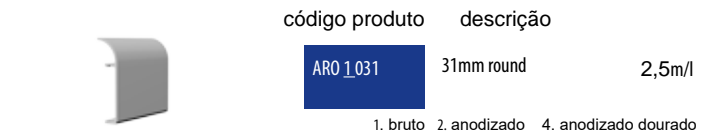

PERFIL LATERAL

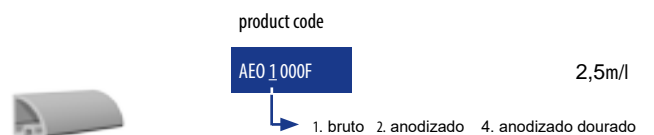

DIRETÓRIO

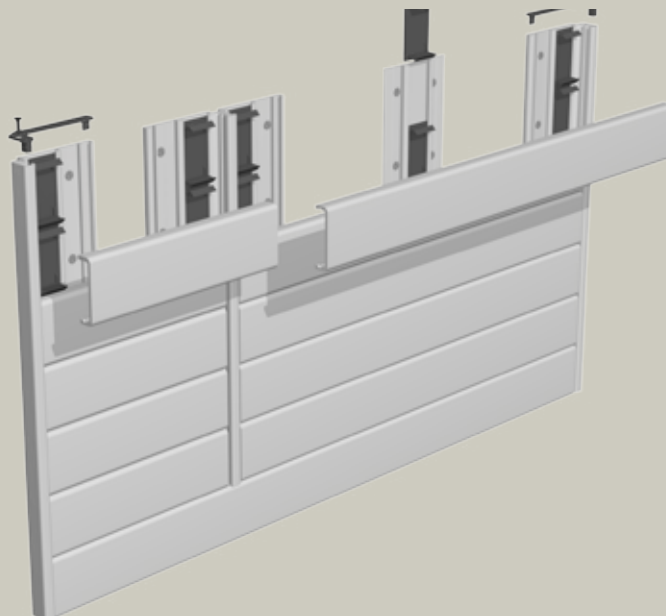

TERMINAIS PARA PERFIS LATERAIS



código produto descrição

APT 3 000

reto

2. cinza 3. preto



APT 3 000B

reto

2. cinza 3. preto



APT 3 000L

round

2. cinza 3. preto



APT 3 000T

triangular / triangle

2. cinza 3. preto



APT 3 003R

round

2. cinza 3. preto

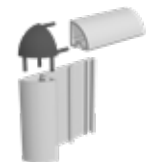

APT 3 006R

perfil lateral

2. cinza 3. preto

CLIPES PARA PERFIS LATERAIS

código produto descrição

APC 5000

clips 31mm

APC 5001

clips 15mm

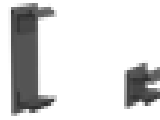

APC5000LS

clips 6x31mm