

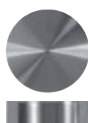













# CAPAS DECORATIVAS

 <p>diametro: 12mm   25mm</p>	 <p>diametro: 12mm   15mm</p>	 <p>diametro: 15mm</p>	 <p>diametro: 15   30mm</p>
micro  	micro  	micro alu  	micro steel  
 <p>diametro: 15mm</p>	 <p>diametro: 15mm</p>	 <p>diametro: 11   15mm</p>	
nano   	ring kombo  	ring steel 	

A tampa de rosca decorativa é um elemento fundamental para enriquecer e completar o visual das placas de parede. Escolha a cor certa para você! Sem parafusos à vista, para obter resultados que comunicam estilo, elegância e atenção aos detalhes.

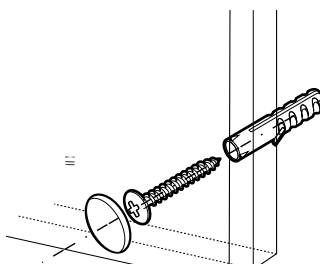

# MICRO

## TAMPAS DE PARAFUSO DE PRESSÃO

Tampa de pressão elegante. O painel fixa-se à parede diretamente com a microfixação. Fixe a tampa do parafuso por pressão e sem ferramentas diretamente no anel. Ideal quando confrontado com a necessidade de uma montagem rápida. Fixação: sistema de parafusos de pressão, montagem frontal, simples e rápida.

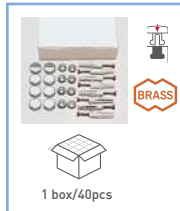
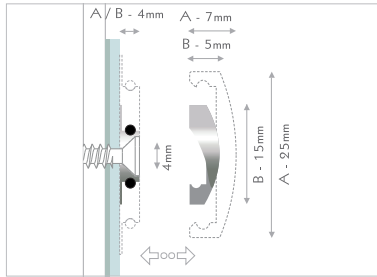
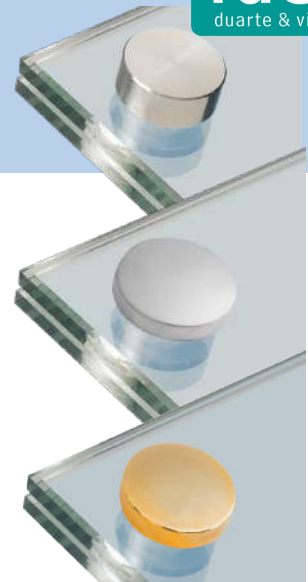

A	MICRO	descrição	PEDIDO MINIMO 1box/40pcs		
1	FMI1500CM	cromado			
2	FMI2500CM	cromado			
3	FMI1500AR	aluminio			
4	FMI2500AR	aluminio			
5	FMI1500GD	ouro satinado			
6	FMI2500GD	ouro satinado			

# MICRO PLAST

## TAMPAS DE PARAFUSO DE PRESSÃO

Fixação rápida para montar. Sistema invisível, projetado para dar o máximo de destaque ao painel. Poucas medidas a tomar, praticidade absoluta. Aplicação da placa com pressão manual. Distância da parede: 20mm.

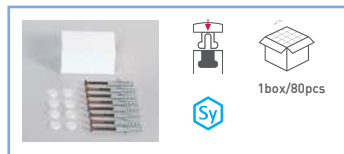
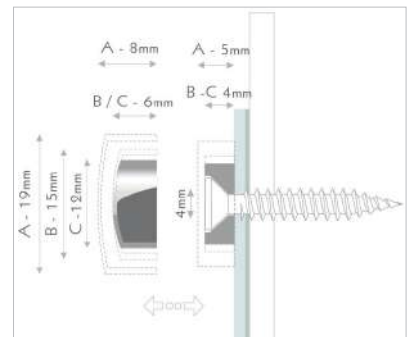

A	MICRO PLAST	descriçione	PEDIDO MINIMO 1box/80pcs		
7	FMISY1000WE	branco ø12mm			
8	FMISY1500WE	branco ø15mm			

## MICRO ALU

SISTEMA DE FIXAÇÃO COM  
TAMPAS PARAFUSADAS



Fixação com tampa de rosca de alumínio que não deixa distância entre o painel e a parede. Capa decorativa disponível nas cores dourado, preto e prata.

Material: alumínio de alta resistência. Aplicação rápida da cobertura decorativa. Para uma solução de alto impacto, mas econômica!

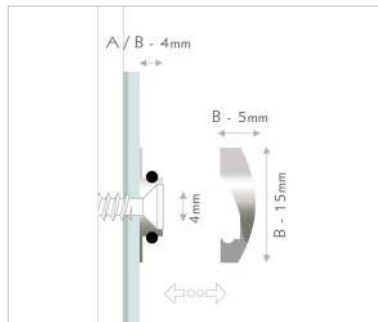

O kit de venda inclui as tampas de rosca, parafusos e buchas que compõem o kit de montagem

1 box 40pcs

sistema a incastro

material

A	MICRO ALU	descrição	PEDIDO MINIMO	1box/40pcs
1	FAL1500ARSET08	alumínio		
2	FAL1500SZSET08	preto		
3	FAL1500GDSET08	ouro satinato		

# MICRO STEEL

TAMPA DO PARAFUSO DE PRESSÃO DE PRESSÃO

Elegante tampa de pressão em aço inoxidável. Basta fixar a tampa roscada de pressão, sem ferramentas, no anel e... o jogo está feito! montagem frontal. Ideal para áreas de montagem inacessíveis, pois é aplicado pela frente!

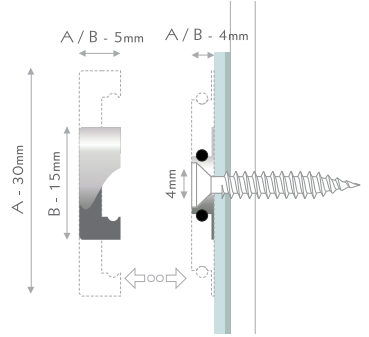
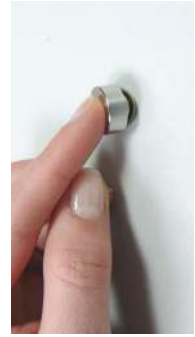
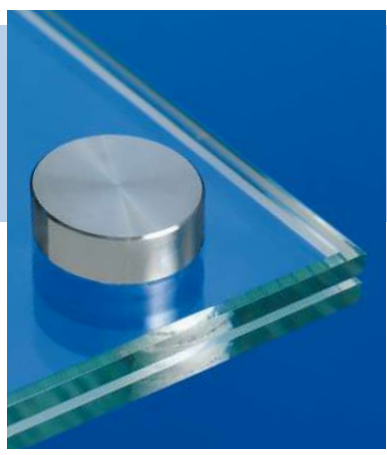

A	MICRO STEEL	descrição	PEDIDO MINIMO	1 box/40pcs
1	FMI1500IX	aço, ø15mm		
2	FMI3000IX	aço, ø30mm		

# NANO

TAMPA DE PARAFUSO DECORATIVA

Tampa roscada com arruela para fixação na parede por meio de um parafuso de conexão sem distância. Para a fixação bastam pequenos furos de Ø5 mm. O Fisso Nano possui um furo lateral para acilitar a montagem. Simples e rápido de aplicar.

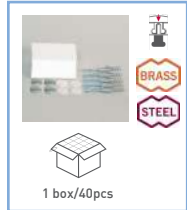
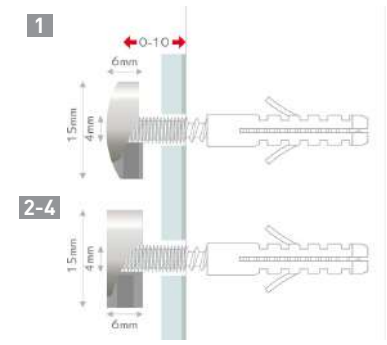
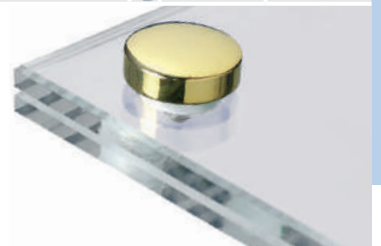
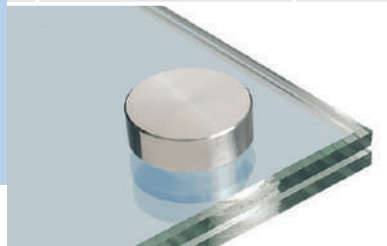

A	NANO	descrição	PEDIDO MINIMO	1 box/40pcs
1	FNANO15CM	cromado		
2	FNANO15AR	alumínio		
3	FNANO15GD	ouro		
4	FNANO15IX	aço		

## RING KOMBO

TAMPA DE PARAFUSO DE AÇO INOXIDÁVEL

Parafuso torx em aço inoxidável, equipado com anel de aço e junta de proteção de borracha.

Esse recurso permite que a placa não seja riscada / danificada.

Ideal para montagem frontal.

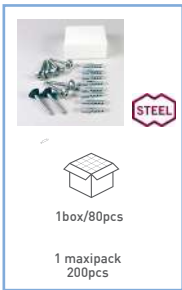
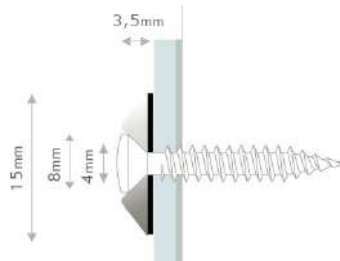

**A RING KOMBO** descrição **PEDIDO MINIMO** 1box/80pcs

1 FRING15KB ring cromado

**A RING KOMBO MAXIPACK** descrição 1max/200pcs

2 FRINGMP15KB ring cromado

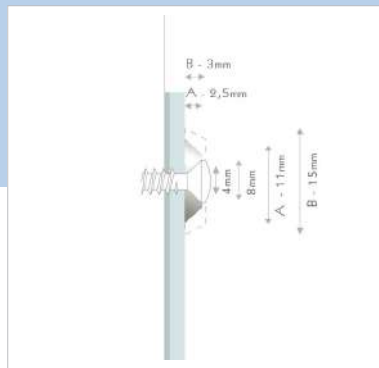

## RING STEEL

TAMPA DE PARAFUSO DE AÇO INOXIDÁVEL

Roseta universal, com parafuso torx de aço inoxidável. Montagem direta na parede para qualquer tipo de painel.

A roseta universal tem uma forma alargada que acomoda perfeitamente o parafuso, dando-lhe a máxima estabilidade.

3

4

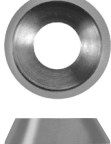

**A RING STEEL** descrição **PEDIDO MINIMO** 1box/40pcs

3 FRG11IX aço, ø11mm

4 FRG15IX aço, ø15mm